

M8-Round-Plug Connector, Single-Ended Cordsets
RSMV 3 | RSMV 4 | RSMWV 3 | RSMWV 4

RSMV | RSMWV



3- and 4-Poles

Actuator/sensor cordset, single-ended, M8, 3- and 4-poles male straight connector with self-locking threaded joint and molded cable.

RSMV



Actuator/sensor cordset, single-ended, M8, 3- and 4-poles male 90° connector with self-locking threaded joint and molded cable.

RSMWV

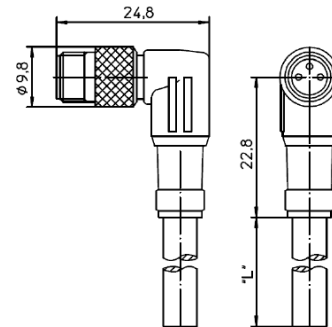

Pin Assignments

M8

3 poles

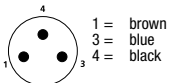

4 poles

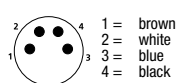

Be Certain with Belden

Cordsets
Single-Ended



M8-Round-Plug Connector, Single-Ended Cordsets

RSMV 3 | RSMV 4 | RSMWV 3 | RSMWV 4

Technical Data

Environmental

Degree of protection IP 67, IP68 (NEMA 6P)
Operating temperature range -30 to +80C

Mechanical

Housing / Molded body TPU grey transparent
Insert (contact bearer) PA/TPU, black
Contact Copper Alloy
Coupling screw Nickel Plated Brass
O-ring n/a









Electrical data

Rated voltage 63V (IEC) / 30V (UL)
Rated current* 4 A

Cable Specifications

| Cable No. | Outer Jacket | Conductor Size | Jacket Color | OD |
|-----------|--------------|-----------------|--------------|-----------------|
| 593 | PVC | 22 AWG stranded | yellow | 5.00 mm nominal |
| 594 | PVC | 22 AWG stranded | yellow | 5.20 mm nominal |

Cordsets
Single-Ended

| Part Number | Pins | Outer Jacket | Standard Cable Lengths | Characteristics |
|----------------------|------|--------------|------------------------|---|
| Male Straight | | | | |
| | | | | Male 90° |
| RSMV 3-593/...M | 3 | PVC | 2M / 5M / 10M |     |
| RSMV 4-594/...M | 4 | PVC | 2M / 5M / 10M |     |